

Product Summary

$V_{(BR)DSS}$	$R_{DS(on)TYP}$	I_D
50V	1.0Ω@10V	220mA
	1.1Ω@4.5V	

Feature

- High density cell design for extremely low $R_{DS(on)}$
- Rugged and Reliable

Application

- Direct Logic-Level Interface: TTL/CMOS
- Drivers: Relays, Solenoids, Lamps, Hammers, Display, Memories, Transistors
- Battery Operated Systems
- Solid-State Relays

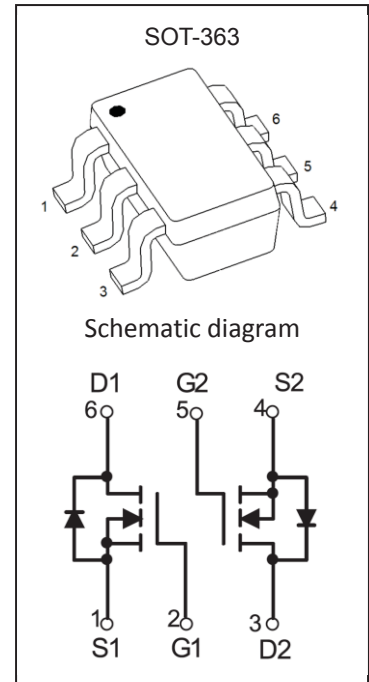

ABSOLUTE MAXIMUM RATINGS ($T_a=25^\circ\text{C}$ unless otherwise noted)

Parameter	Symbol	Value	Unit
Drain-Source Voltage	V_{DS}	50	V
Gate-Source Voltage	V_{GS}	± 20	V
Continuous Drain Current	I_D	0.22	A
Power Dissipation	P_D	150	mW
Thermal Resistance from Junction to Ambient	$R_{\theta JA}$	833	$^\circ\text{C/W}$
Junction Temperature	T_J	150	$^\circ\text{C}$
Storage Temperature	T_{STG}	-55~ +150	$^\circ\text{C}$

MOSFET ELECTRICAL CHARACTERISTICS ($T_a=25^{\circ}\text{C}$ unless otherwise noted)

Parameter	Symbol	Test Condition	Min	Type	Max	Unit
Static Characteristics						
Drain-source breakdown voltage	$V_{(BR)DSS}$	$V_{GS} = 0V, I_D = 250\mu A$	50			V
Zero gate voltage drain current	I_{DSS}	$V_{DS} = 50V, V_{GS} = 0V$			0.5	μA
Gate-body leakage current	I_{GSS}	$V_{GS} = \pm 20V, V_{DS} = 0V$			± 100	nA
Gate threshold voltage ¹	$V_{GS(th)}$	$V_{DS} = V_{GS}, I_D = 1mA$	0.8	1.2	1.5	V
Drain-source on-resistance ¹	$R_{DS(on)}$	$V_{GS} = 10V, I_D = 220mA$		1.0	3.0	Ω
		$V_{GS} = 4.5V, I_D = 220mA$		1.1	5.0	
Forward transconductance ¹	g_{FS}	$V_{DS} = 10V, I_D = 220mA$		0.15		S
Dynamic characteristics²						
Input Capacitance	C_{iss}	$V_{DS} = 25V, V_{GS} = 0V, f = 1MHz$		26.5		pF
Output Capacitance	C_{oss}			12.9		
Reverse Transfer Capacitance	C_{rss}			5.9		
Switching Characteristics^{1,2}						
Turn-on delay time	$t_{d(on)}$	$V_{DD} = 30V, I_D = 290mA,$ $V_{GS} = 10V, R_G = 6\Omega$			5	nS
Turn-on rise time	t_r				18	
Turn-off delay time	$t_{d(off)}$				36	
Turn-off fall time	t_f				14	
Source-Drain Diode characteristics¹						
Diode Forward voltage	V_{DS}	$I_S = 440mA, V_{GS} = 0V$			1.4	V

Notes:

1. Pulse Test ; Pulse Width $\leq 300\mu s$, Duty Cycle $\leq 2\%$.
2. These parameters have no way to verify.

Typical Electrical and Thermal Characteristics

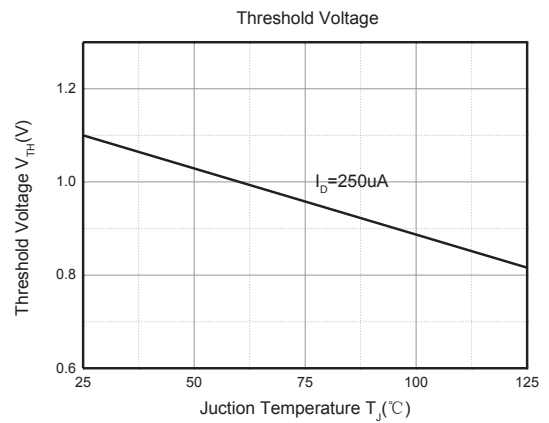
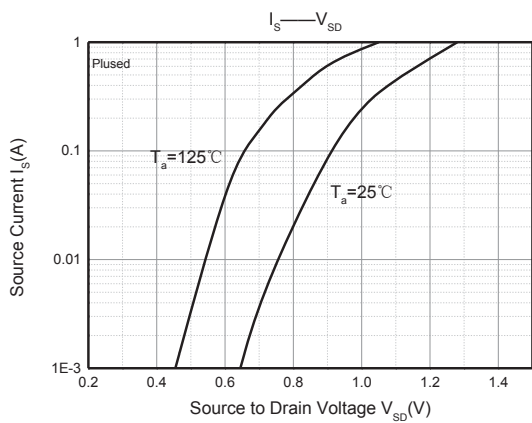
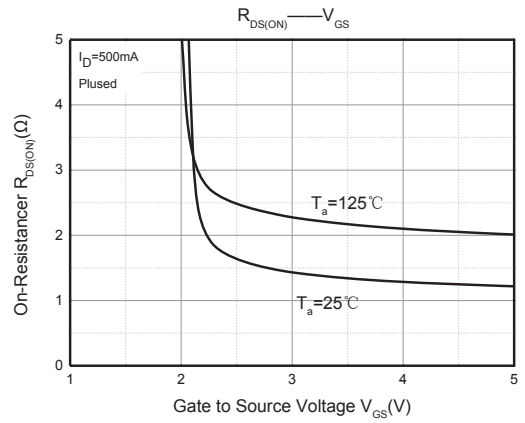
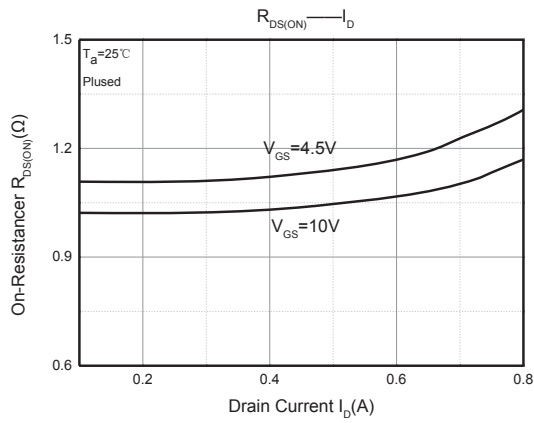
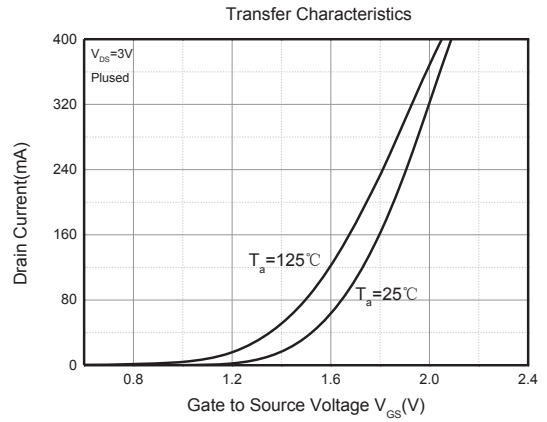
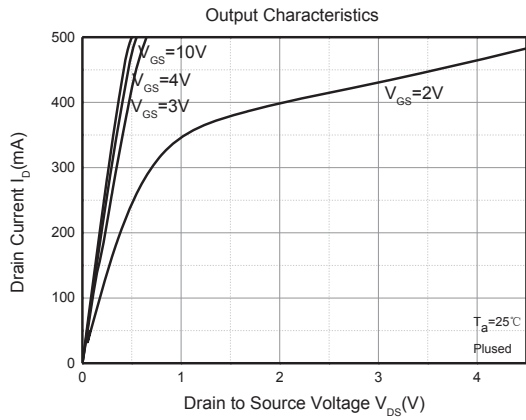

SOT-363 Package Information

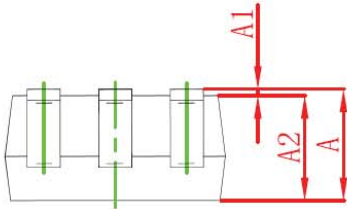
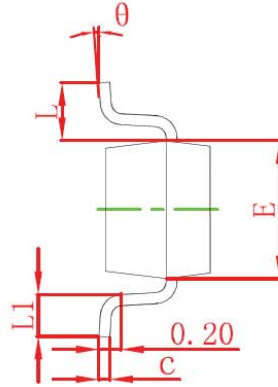
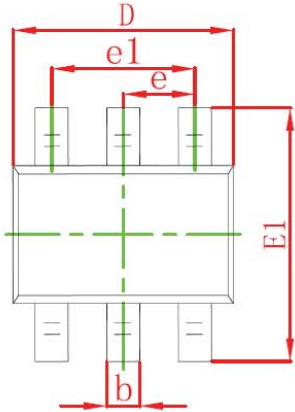

Symbol	Dimensions In Millimeters		Dimensions In Inches	
	Min	Max	Min	Max
A	0.900	1.100	0.035	0.043
A1	0.000	0.100	0.000	0.004
A2	0.900	1.000	0.035	0.039
b	0.150	0.350	0.006	0.014
c	0.100	0.150	0.004	0.006
D	2.000	2.200	0.079	0.087
E	1.150	1.350	0.045	0.053
E1	2.150	2.400	0.085	0.094
e	0.650 TYP		0.026 TYP	
e1	1.200	1.400	0.047	0.055
L	0.525 REF		0.021 REF	
L1	0.260	0.460	0.010	0.018
θ	0°	8°	0°	8°

SOT-363 Tape and Reel

SOT-363 Tape and reel

SOT-363 Embossed Carrier Tape

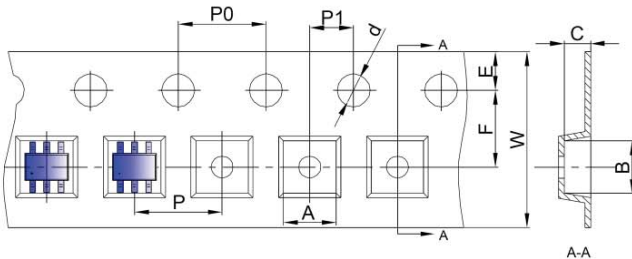

Packaging Description:

SOT-363 parts are shipped in tape. The carrier tape is made from a dissipative (carbon filled) polycarbonate resin. The cover tape is a multilayer film (Heat Activated Adhesive in nature) primarily composed of polyester film, adhesive layer, sealant, and anti-static sprayed agent. These reeled parts in standard option are shipped with 3,000 units per 7" or 17.8cm diameter reel. The reels are clear in color and is made of polystyrene plastic (anti-static coated).

Dimensions are in millimeter										
Pkg type	A	B	C	d	E	F	P0	P	P1	W
SOT-363	2.25	2.55	1.20	Ø1.50	1.75	3.50	4.00	4.00	2.00	8.00

SOT-363 Tape Leader and Trailer

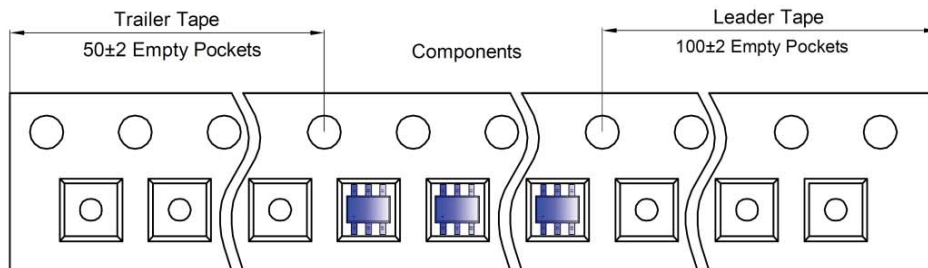

SOT-363 Reel

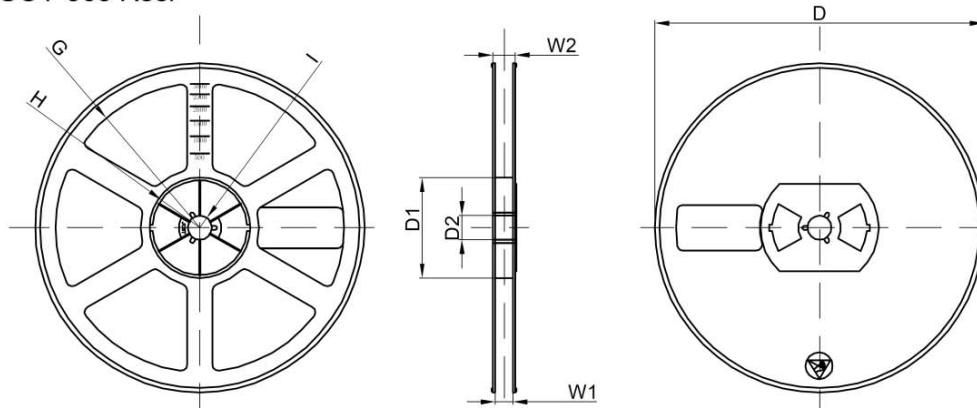

Dimensions are in millimeter								
Reel Option	D	D1	D2	G	H	I	W1	W2
7" Dia	Ø178.00	54.40	13.00	R78.00	R25.60	R6.50	9.50	12.30

REEL	Reel Size	Box	Box Size(mm)	Carton	Carton Size(mm)	G.W.(kg)
3000 pcs	7 inch	30,000 pcs	203×203×195	120,000 pcs	438×438×220	