

CSTS8050S23 TRANSISTOR (NPN)

FEATURES

- Complimentary to S8550
- Collector Current: $I_C=0.5A$

MARKING: J3Y

MAXIMUM RATINGS ($T_a=25^\circ C$ unless otherwise noted)

Symbol	Parameter	Value	Unit
V_{CBO}	Collector-Base Voltage	40	V
V_{CEO}	Collector-Emitter Voltage	25	V
V_{EBO}	Emitter-Base Voltage	5	V
I_C	Collector Current	500	mA
P_C	Collector Power Dissipation	300	mW
$R_{\theta JA}$	Thermal Resistance From Junction To Ambient	417	$^\circ C/W$
T_J, T_{stg}	Operation Junction and Storage Temperature Range	-55~+150	$^\circ C$

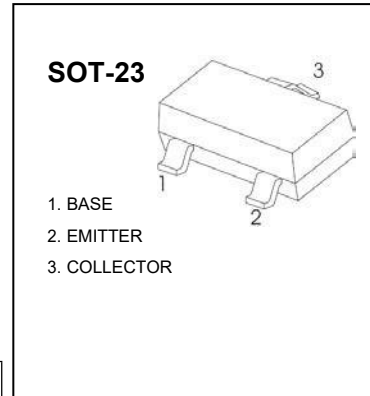

ELECTRICAL CHARACTERISTICS ($T_a=25^\circ C$ unless otherwise specified)

Parameter	Symbol	Test conditions	Min	Typ	Max	Unit
Collector-base breakdown voltage	$V_{(BR)CBO}$	$I_C=100\mu A, I_E=0$	40			V
Collector-emitter breakdown voltage	$V_{(BR)CEO}$	$I_C=1mA, I_B=0$	25			V
Emitter-base breakdown voltage	$V_{(BR)EBO}$	$I_E=100\mu A, I_C=0$	5			V
Collector cut-off current	I_{CBO}	$V_{CB}=40V, I_E=0$			0.1	μA
Collector cut-off current	I_{CEO}	$V_{CB}=20V, I_E=0$			0.1	μA
Emitter cut-off current	I_{EBO}	$V_{EB}=5V, I_C=0$			0.1	μA
DC current gain	$h_{FE(1)}$	$V_{CE}=1V, I_C=50mA$	120		400	
	$h_{FE(2)}$	$V_{CE}=1V, I_C=500mA$	50			
Collector-emitter saturation voltage	$V_{CE(sat)}$	$I_C=500mA, I_B=50mA$			0.6	V
Base-emitter saturation voltage	$V_{BE(sat)}$	$I_C=500mA, I_B=50mA$			1.2	V
Transition frequency	f_T	$V_{CE}=6V, I_C=20mA$ $f=30MHz$	150			MHz

CLASSIFICATION OF $h_{FE(1)}$

Rank	L	H	J
Range	120-200	200-350	300-400

Typical Characteristics

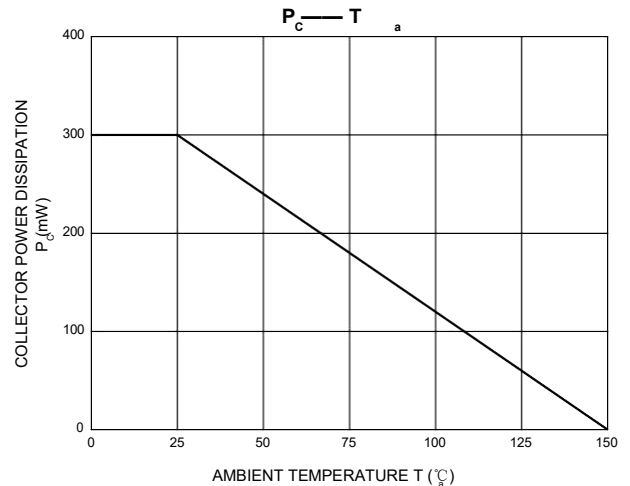
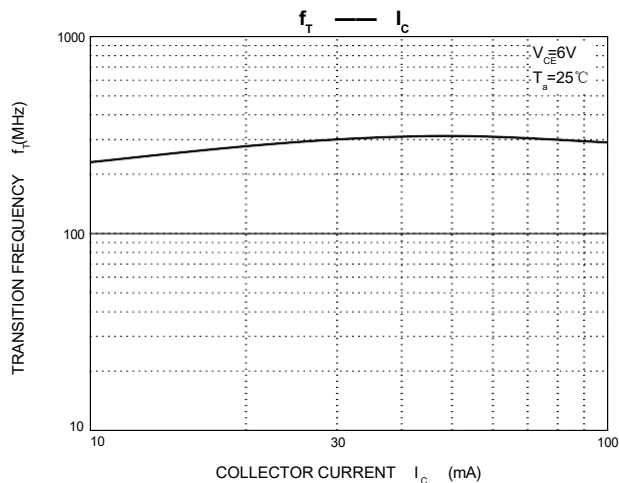
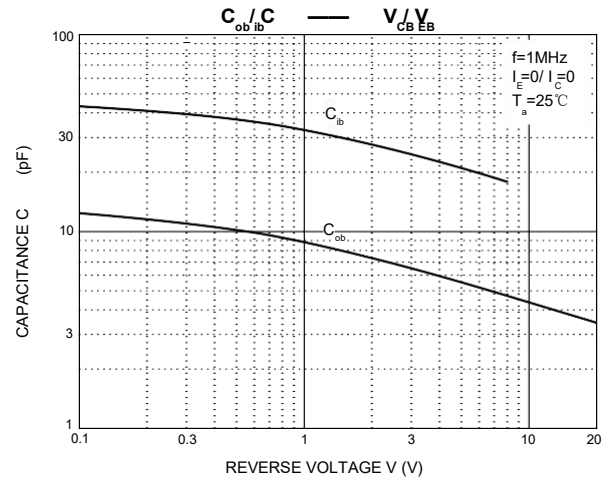
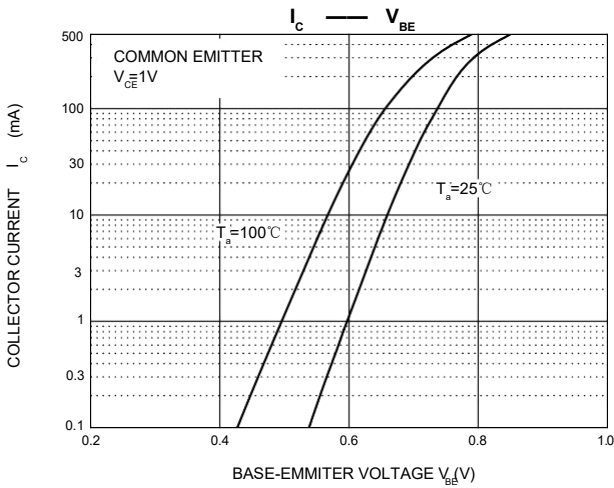
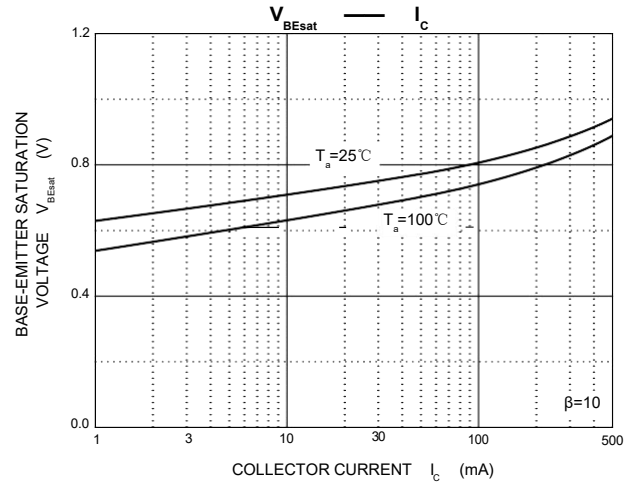
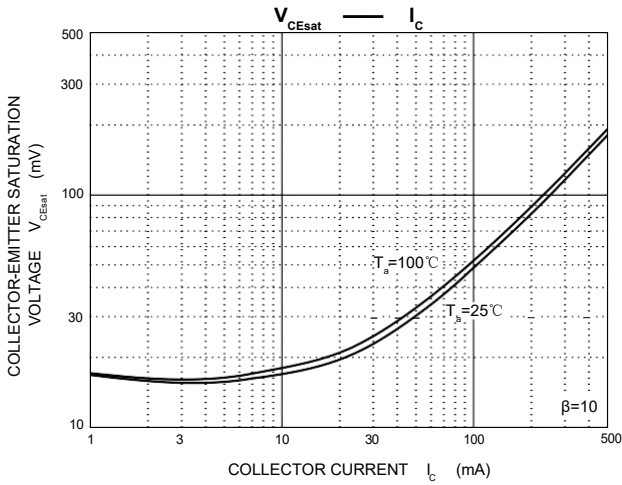
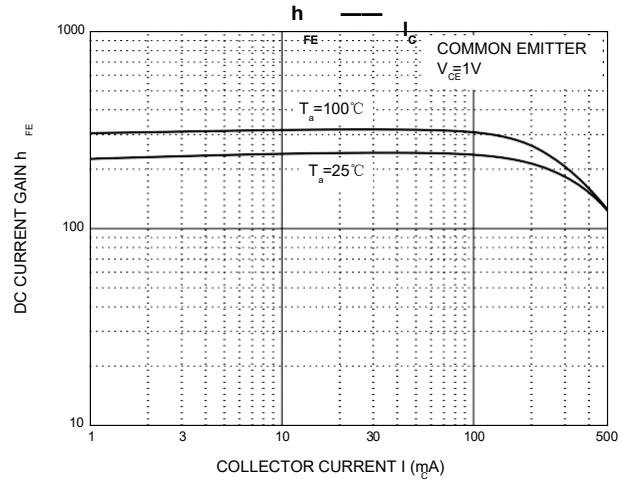
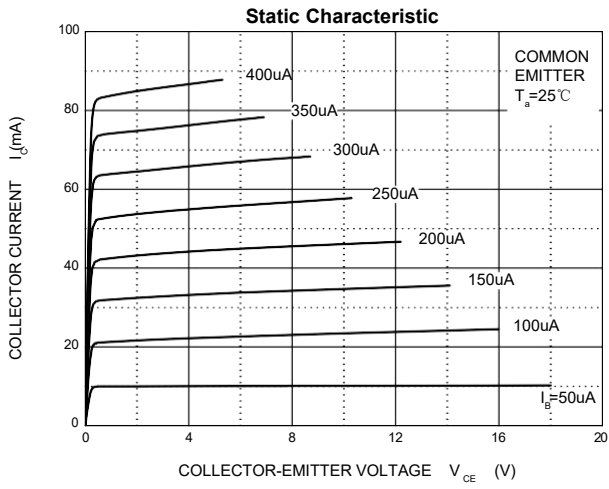

SOT-23 Package Outline Dimensions

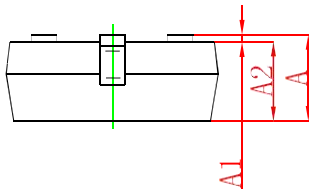
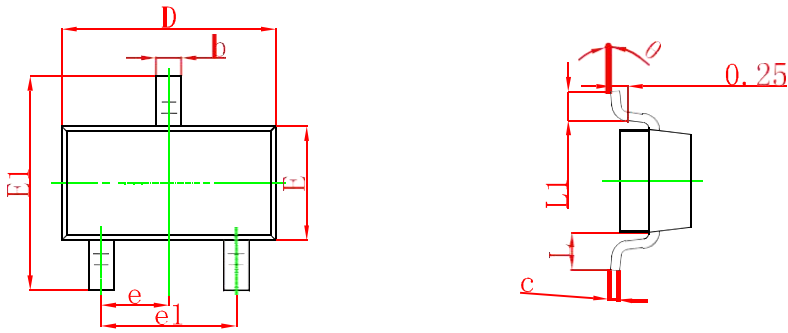

Symbol	Dimensions In Millimeters		Dimensions In Inches	
	Min	Max	Min	Max
A	0.900	1.150	0.035	0.045
A1	0.000	0.100	0.000	0.004
A2	0.900	1.050	0.035	0.041
b	0.300	0.500	0.012	0.020
c	0.080	0.150	0.003	0.006
D	2.800	3.000	0.110	0.118
E	1.200	1.400	0.047	0.055
E1	2.250	2.550	0.089	0.100
e	0.950 TYP		0.037 TYP	
e1	1.800	2.000	0.071	0.079
L	0.550 REF		0.022 REF	
L1	0.300	0.500	0.012	0.020
theta	0°	8°	0°	8°

SOT-23 Suggested Pad Layout

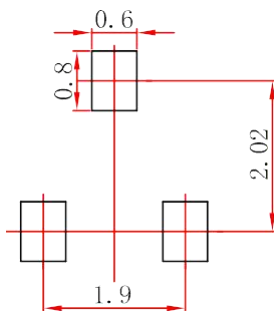

- Note:
1. Controlling dimension: in millimeters.
 2. General tolerance: ± 0.05 mm.
 3. The pad layout is for reference purposes only.

Notice

Specifications of the products displayed herein are subject to change without notice. CCS or anyone on its behalf, assumes no responsibility or liability for any errors or inaccuracies.

Information contained herein is intended to provide a product description only. No license, express or implied, to any intellectual property rights is granted by this document. Except as provided in CCS terms and conditions of sale for such products, CCS assumes no liability whatsoever, and disclaims any express or implied warranty, relating to sale and/or use of CCS products including liability or warranties relating to fitness for a particular purpose, merchant ability, or infringement of any patent, copyright, or other intellectual property right.

The products shown herein are not designed for use in medical, life-saving, or life-sustaining applications.

Customers using or selling these products for use in such applications do so at their own risk and agree to fully indemnify CCS for any damages resulting from such improper use or sale.