

CST3904S23 TRANSISTOR (NPN)

FEATURES

- Complementary to CST3906S23

MAXIMUM RATINGS ($T_a=25^\circ\text{C}$ unless otherwise noted)

Symbol	Parameter	Value	Unit
V_{CBO}	Collector-Base Voltage	60	V
V_{CEO}	Collector-Emitter Voltage	40	V
V_{EBO}	Emitter-Base Voltage	6	V
I_C	Collector Current	200	mA
P_C	Collector Power Dissipation	200	mW
$R_{\theta JA}$	Thermal Resistance From Junction To Ambient	625	$^\circ\text{C}/\text{W}$
T_J, T_{stg}	Operation Junction and Storage Temperature Range	-55~+150	$^\circ\text{C}$

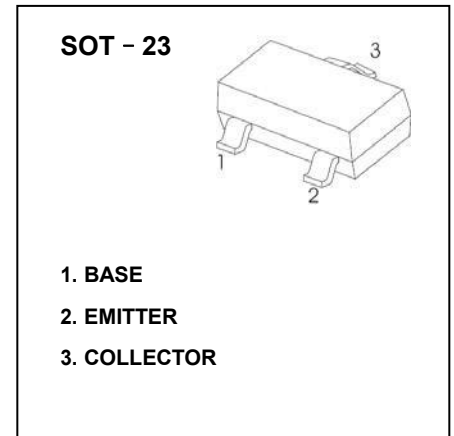

ELECTRICAL CHARACTERISTICS ($T_a=25^\circ\text{C}$ unless otherwise specified)

Parameter	Symbol	Test conditions	Min	Typ	Max	Unit
Collector-base breakdown voltage	$V_{(BR)CBO}$	$I_C=10\mu\text{A}, I_E=0$	60			V
Collector-emitter breakdown voltage	$V_{(BR)CEO}$	$I_C=1\text{mA}, I_B=0$	40			V
Emitter-base breakdown voltage	$V_{(BR)EBO}$	$I_E=10\mu\text{A}, I_C=0$	6			V
Collector cut-off current	I_{CEX}	$V_{CE}=30\text{V}, V_{EB(off)}=3\text{V}$			50	nA
Collector cut-off current	I_{CBO}	$V_{CB}=60\text{V}, I_E=0$			100	nA
Emitter cut-off current	I_{EBO}	$V_{EB}=5\text{V}, I_C=0$			100	nA
DC current gain	$h_{FE(1)}$	$V_{CE}=1\text{V}, I_C=10\text{mA}$	100		300	
	$h_{FE(2)}$	$V_{CE}=1\text{V}, I_C=50\text{mA}$	60			
	$h_{FE(3)}$	$V_{CE}=1\text{V}, I_C=100\text{mA}$	30			
Collector-emitter saturation voltage	$V_{CE(sat)}$	$I_C=50\text{mA}, I_B=5\text{mA}$			0.3	V
Base-emitter saturation voltage	$V_{BE(sat)}$	$I_C=50\text{mA}, I_B=5\text{mA}$			0.95	V
Transition frequency	f_T	$V_{CE}=20\text{V}, I_C=10\text{mA}, f=100\text{MHz}$	300			MHz
Delay time	t_d	$V_{CC}=3\text{V}, V_{BE(off)}=-0.5\text{V}, I_C=10\text{mA}, I_{B1}=1\text{mA}$			35	ns
Rise time	t_r	$V_{CC}=3\text{V}, V_{BE(off)}=-0.5\text{V}, I_C=10\text{mA}, I_{B1}=1\text{mA}$			35	ns
Storage time	t_s	$V_{CC}=3\text{V}, I_C=10\text{mA}, I_{B1}=I_{B2}=1\text{mA}$			200	ns
Fall time	t_f	$V_{CC}=3\text{V}, I_C=10\text{mA}, I_{B1}=I_{B2}=1\text{mA}$			50	ns

CLASSIFICATION OF $h_{FE(1)}$

HFE	100-300	
RANK	L	H
RANGE	100 - 200	200 - 300

Typical Characteristics

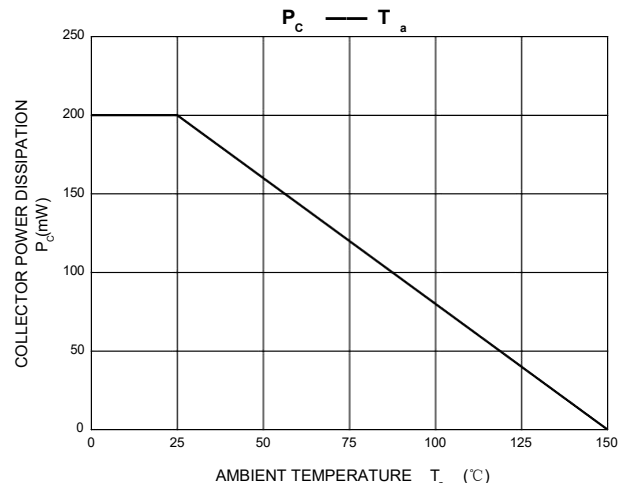
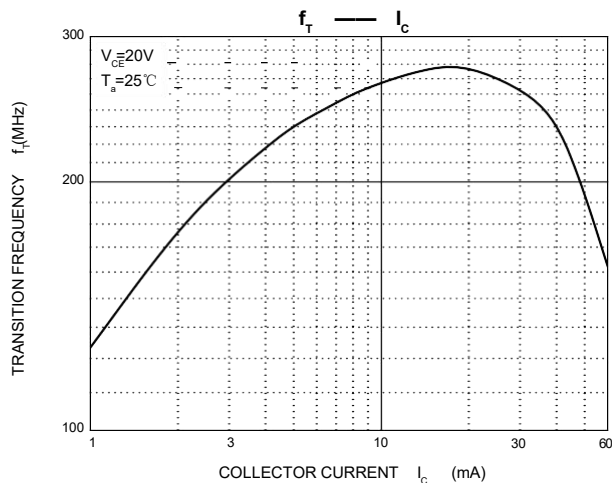
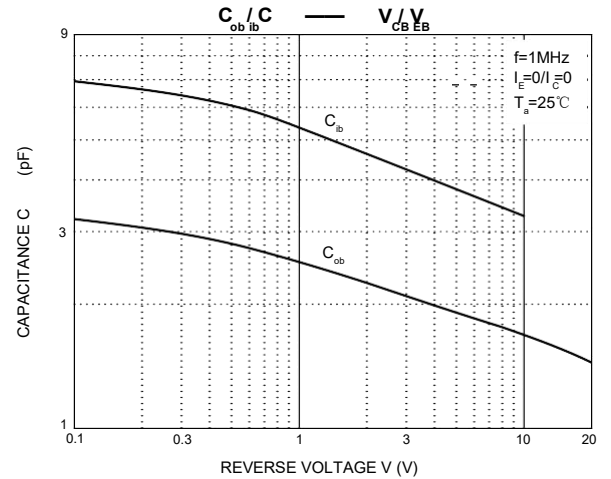
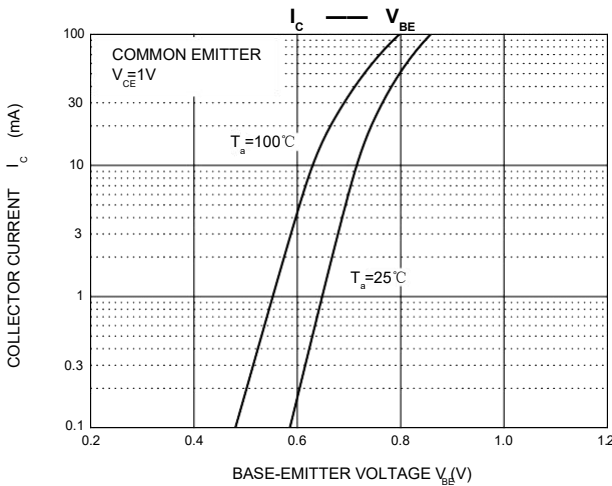
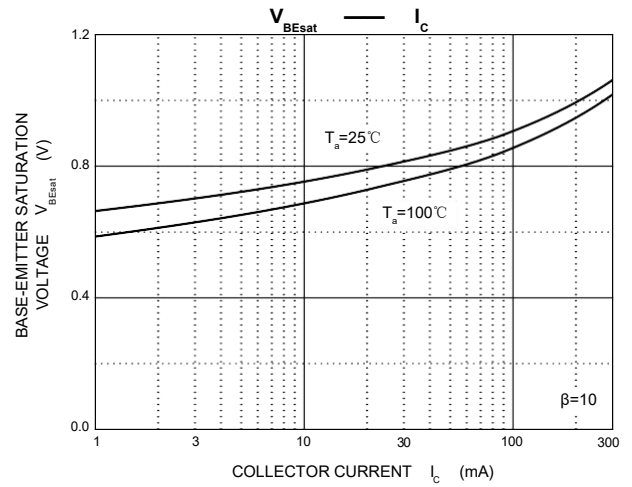
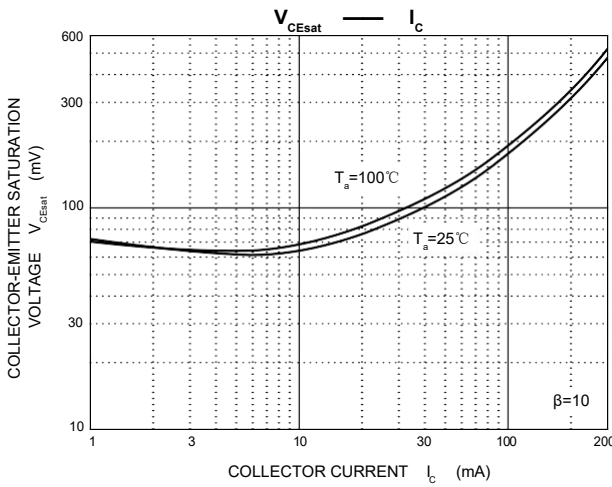
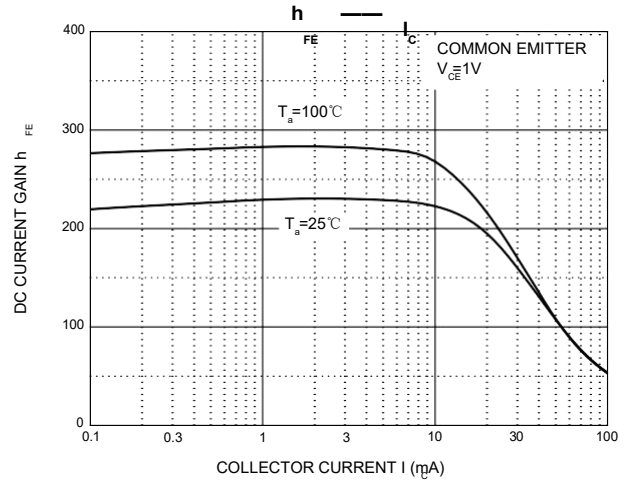
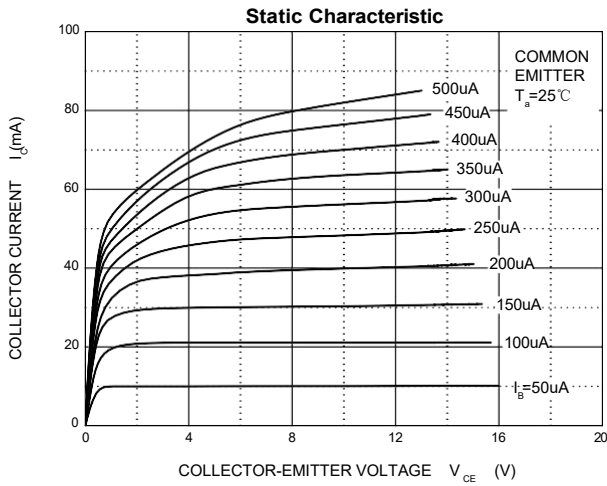

SOT-23 Package Outline Dimensions

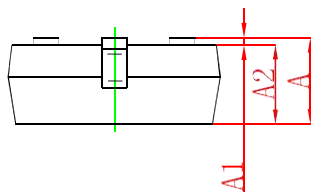
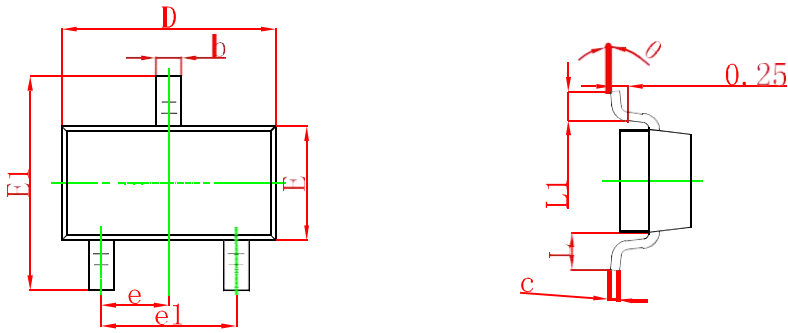

Symbol	Dimensions In Millimeters		Dimensions In Inches	
	Min	Max	Min	Max
A	0.900	1.150	0.035	0.045
A1	0.000	0.100	0.000	0.004
A2	0.900	1.050	0.035	0.041
b	0.300	0.500	0.012	0.020
c	0.080	0.150	0.003	0.006
D	2.800	3.000	0.110	0.118
E	1.200	1.400	0.047	0.055
E1	2.250	2.550	0.089	0.100
e	0.950 TYP		0.037 TYP	
e1	1.800	2.000	0.071	0.079
L	0.550 REF		0.022 REF	
L1	0.300	0.500	0.012	0.020
θ	0°	8°	0°	8°

SOT-23 Suggested Pad Layout

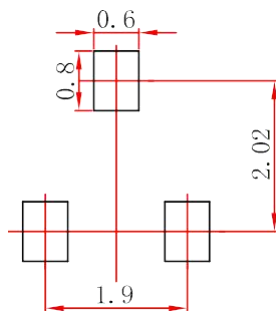

- Note:
1. Controlling dimension: in millimeters.
 2. General tolerance: $\pm 0.05\text{mm}$.
 3. The pad layout is for reference purposes only.

Notice

Specifications of the products displayed herein are subject to change without notice. CCS or anyone on its behalf, assumes no responsibility or liability for any errors or inaccuracies.

Information contained herein is intended to provide a product description only. No license, express or implied, to any intellectual property rights is granted by this document. Except as provided in CCS terms and conditions of sale for such products, CCS assumes no liability whatsoever, and disclaims any express or implied warranty, relating to sale and/or use of CCS products including liability or warranties relating to fitness for a particular purpose, merchant ability, or infringement of any patent, copyright, or other intellectual property right.

The products shown herein are not designed for use in medical, life-saving, or life-sustaining applications.

Customers using or selling these products for use in such applications do so at their own risk and agree to fully indemnify CCS for any damages resulting from such improper use or sale.