

CST51-52-53S89

TRANSISTOR (PNP)

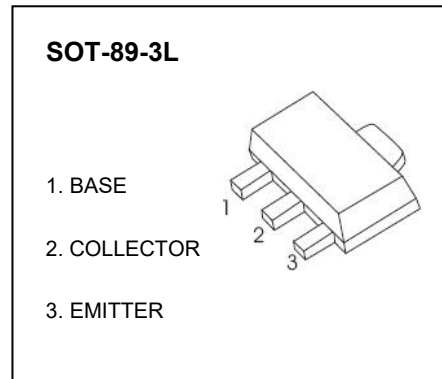

FEATURES

- NPN Complements to CST54,CST55,CST56
- Low Voltage
- High Current

APPLICATIONS

- Medium Power General Purposes
- Driver Stages of Audio Amplifiers

MAXIMUM RATINGS (T_a=25°C unless otherwise noted)

Symbol	Parameter	Value	Unit
V_{CB0}	Collector-Base Voltage	CST51	-45
		CST52	-60
		CST53	-100
V_{CEO}	Collector-Emitter Voltage	CST51	-45
		CST52	-60
		CST53	-80
V_{EBO}	Emitter-Base Voltage	-5	V
I_C	Collector Current	-1	A
P_C	Collector Power Dissipation	500	mW
R_{θJA}	Thermal Resistance From Junction To Ambient	250	°C/W
T_J, T_{stg}	Operation Junction and Storage Temperature Range	-55~+150	°C

ELECTRICAL CHARACTERISTICS (T_a=25°C unless otherwise specified)

Parameter	Symbol	Test conditions	Min	Typ	Max	Unit	
Collector-base breakdown voltage	V _{(BR)CBO}	I _C =-100μA, I _E =0	CST51	-45			V
			CST52	-60			
			CST53	-100			
Collector-emitter breakdown voltage	V _{(BR)CEO*}	I _C =-10mA, I _B =0	CST51	-45			V
			CST52	-60			
			CST53	-80			
Emitter-base breakdown voltage	V _{(BR)EBO}	I _E =-100μA, I _C =0	-5			V	
Collector cut-off current	I _{CBO}	V _{CB} =-30V, I _E =0			-0.1	μA	
Emitter cut-off current	I _{EBO}	V _{EB} =-5V, I _C =0			-0.1	μA	
DC current gain	h _{FE(1)*}	V _{CE} =-2V, I _C =-5mA	63				
	h _{FE(2)*}	V _{CE} =-2V, I _C =-150mA	63		250		
	h _{FE(3)*}	V _{CE} =-2V, I _C =-0.5A	40				
Collector-emitter saturation voltage	V _{CE(sat)*}	I _C =-0.5A, I _B =-50mA			-0.5	V	
Base -emitter voltage	V _{BE*}	V _{CE} =-2V, I _C =-0.5A			-1	V	
Transition frequency	f _T	V _{CE} =-5V, I _C =-10mA, f=100MHz		50		MHz	

* Pulse Test

CLASSIFICATION OF h_{FE(2)}

RANK	CST51	CST51-10	CST51-16
	CST52	CST52-10	CST52-16
	CST53	CST53-10	CST53-16
RANGE	63–250	63–160	100–250

Typical Characteristics

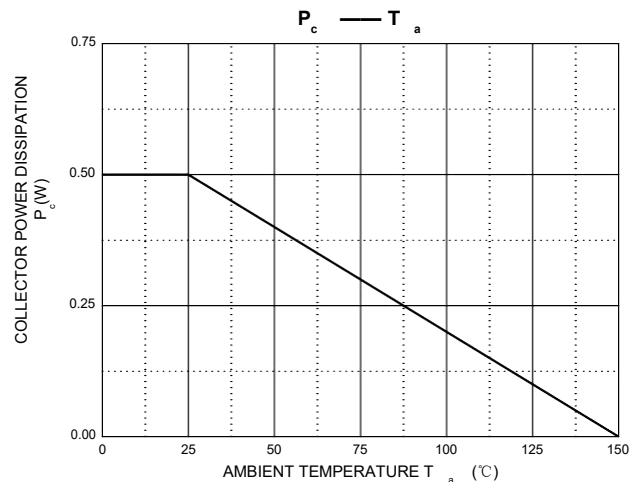
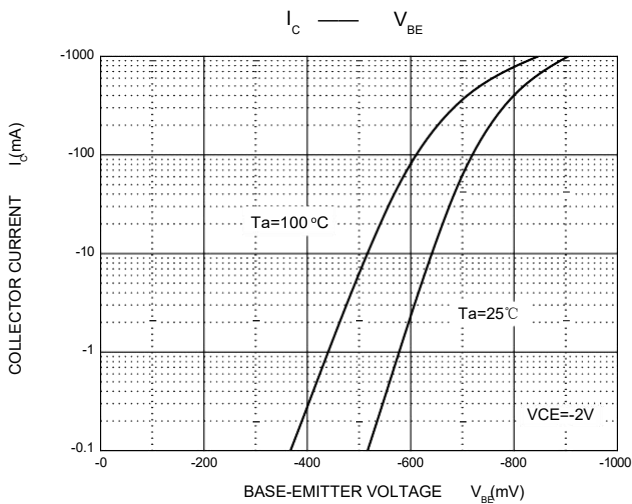
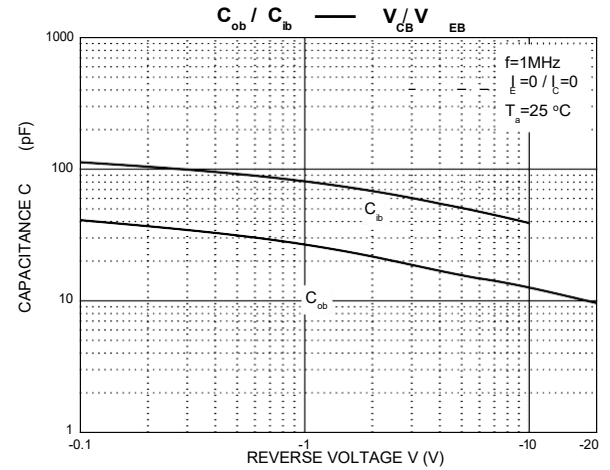
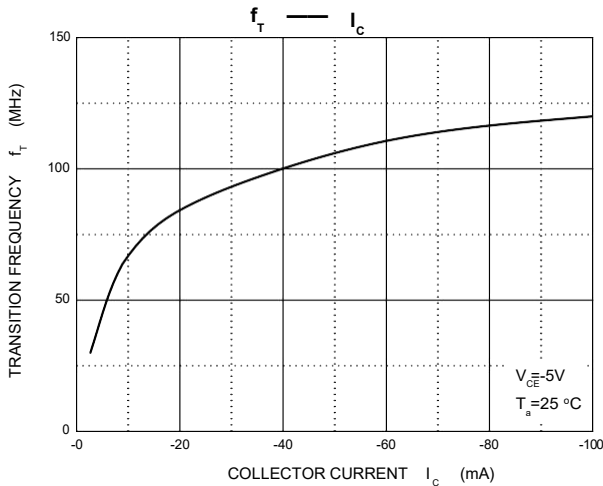
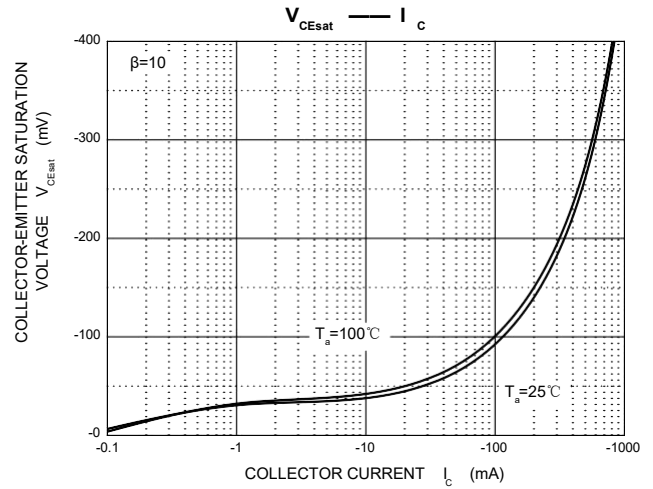
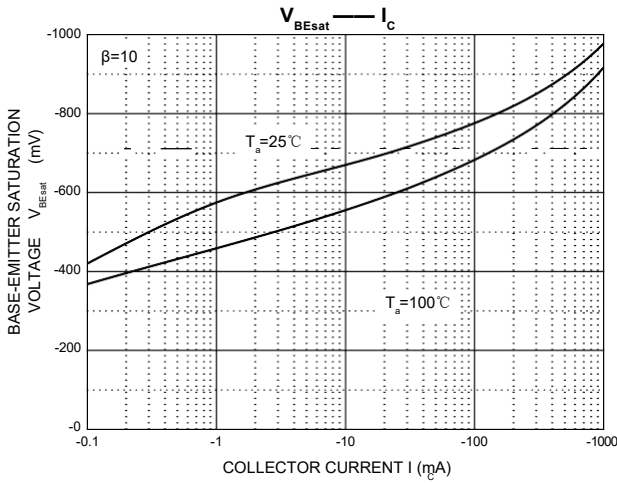
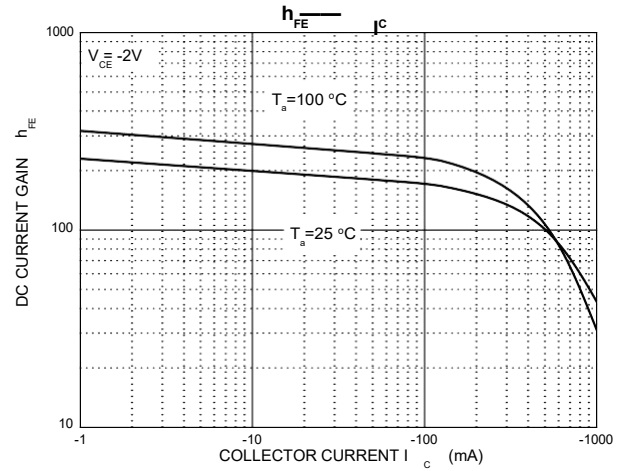
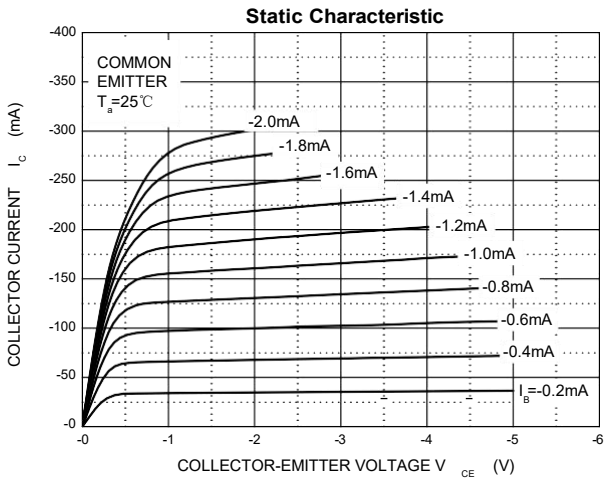

SOT-89-3L Package Outline Dimensions

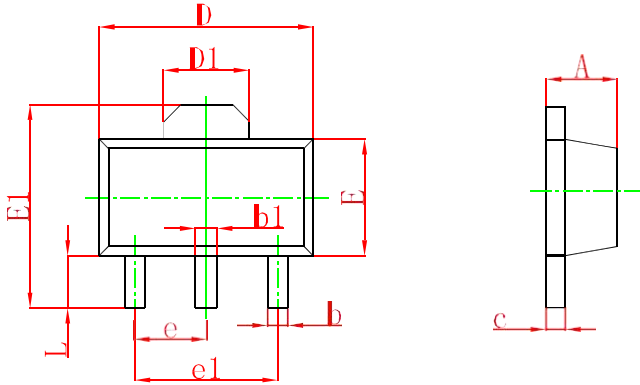

Symbol	Dimensions In Millimeters		Dimensions In Inches	
	Min	Max	Min	Max
A	1.400	1.600	0.055	0.063
b	0.320	0.520	0.013	0.020
b1	0.400	0.580	0.016	0.023
c	0.350	0.440	0.014	0.017
D	4.400	4.600	0.173	0.181
D1	1.550 REF.		0.061 REF.	
E	2.300	2.600	0.091	0.102
E1	3.940	4.250	0.155	0.167
e	1.500 TYP.		0.060 TYP.	
e1	3.000 TYP.		0.118 TYP.	
L	0.900	1.200	0.035	0.047

SOT-89-3L Suggested Pad Layout

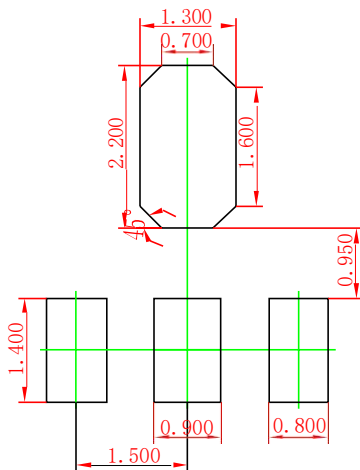

Note:

1. Controlling dimension: in millimeters.
2. General tolerance: $\pm 0.05\text{mm}$.
3. The pad layout is for reference purposes only.

Notice

Specifications of the products displayed herein are subject to change without notice. CCS or anyone on its behalf, assumes no responsibility or liability for any errors or inaccuracies.

Information contained herein is intended to provide a product description only. No license, express or implied, to any intellectual property rights is granted by this document. Except as provided in CCS terms and conditions of sale for such products, CCS assumes no liability whatsoever, and disclaims any express or implied warranty, relating to sale and/or use of CCS products including liability or warranties relating to fitness for a particular purpose, merchant ability, or infringement of any patent, copyright, or other intellectual property right.

The products shown herein are not designed for use in medical, life-saving, or life-sustaining applications.

Customers using or selling these products for use in such applications do so at their own risk and agree to fully indemnify CCS for any damages resulting from such improper use or sale.